

MAGIQ 4 CELL RECESSED

A35142-

base number Color Finishes Reflector Finish
 Temperature (Diamond) Options Options

- To build a product code in our configurator select the specify button on the base model # product page
- To build a manual product code on this datasheet choose from the options listed below in blue font and add the suffix to the base model #

GENERAL

Series: Magiq
 Subseries: Magiq 4 Cell
 Brand: Prolicht
 Division: Architectural
 Mounting Type: Recessed
 Mounting Location: Ceiling
 Subcategory: Downlight

PHYSICAL

Shape: Rectangle
 Length (mm): 145
 Length (in): 5 11/16
 Width (mm): 45
 Width (in): 1 3/4
 Height (mm): 64
 Height (in): 2 1/2
 Ceiling Thickness (mm): 10 / 12.5 / 15 / 25 / 30
 Ceiling Thickness (in): 3/8 or 1/2 or 9/16 or 1 or 1 3/16
 Min. Recessing Depth (mm): 100
 Min. Recessing Depth (in): 3 15/16
 Light Distribution: Downlight
 Weight (kg): 0.265
 Weight (lbs): 0.58
 Fixture Finish: SSR / BKV / CWI / CRY / HAB / UFT / ITA / RUA / FTG / MYG / LOD / PUS / FRO / FUP / KIA / POP / BLS / SPG / MEY / GOH / GUM / CHC / COM / ABZ / JAG / OBR / MOS / ROR
 Holder Finish: WHI / BLK
 Fixture Material: Aluminum Die Cast
 Cut-out Measurements: 138mm / 5 7/16" x 38mm / 1 1/2"

ELECTRICAL

Lamp Type: LED (Zhaga Standard)
 Input Wattage (W): 14.3
 Total Output Wattage (W): 13.3
 Dimming: Tri-Mode (Non-Dimming and Phase Dimming (120Vac only) and 0-10V Dimming)
 Driver Included: No
 Driver Location: Remote
 Driver Type: Constant Current - Universal
 Driver Class: Class 2
 Input Voltage (V): 120 - 277
 Constant Current (MA): 1050
 Upon Request: Lutron

LED

Number of LEDs: 4
 Color Temperature (°K): 2700 / 3000 / 3500 / 4000
 Max. Delivered Lumen (lm): Max 781 / 843 / 860 / 878
 Nominal Lumen (lm): 880 / 954 / 970 / 990
 CRI: >90 CRI
 Lamp Life (hrs): 50000

OPTICAL

Reflector: 8 / 14 / 34

RATINGS AND CERTIFICATIONS

Certified By: CSA Certified to UL and CSA Standards
 IP rating: IP20

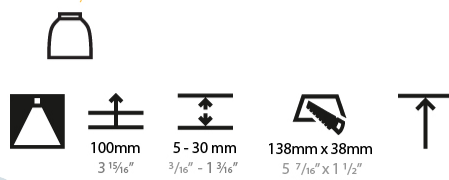

MAGIQ 4 CELL RECESSED

A35142-

PROJECT	_____
TYPE	_____
SPECIFIER	_____
QUANTITY	_____
DATE	_____

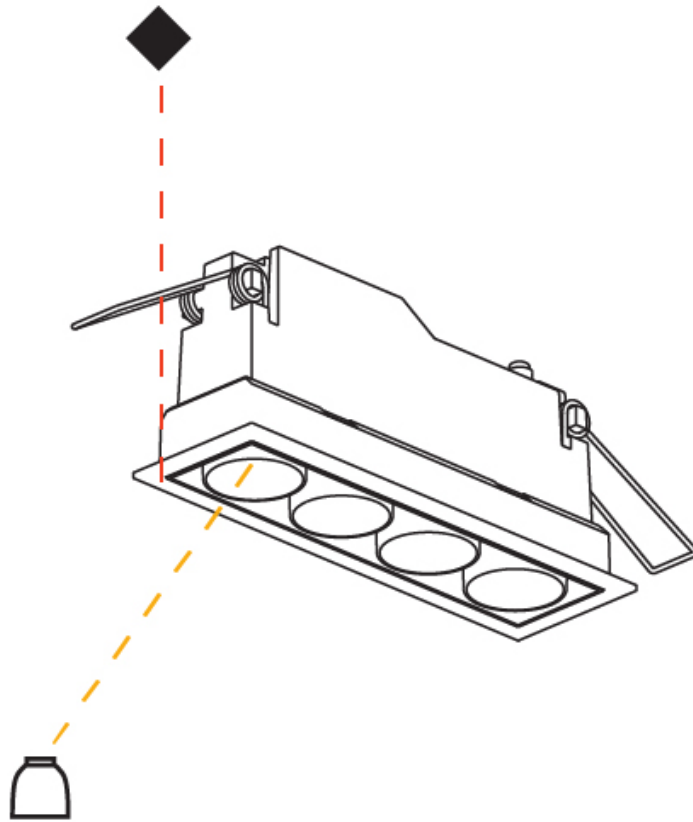

MAGIQ 2X2 CELL RECESSED

A35633-

base number Color Finishes Reflector Finish
 Temperature (Diamond) Options Options

- To build a product code in our configurator select the specify button on the base model # product page
- To build a manual product code on this datasheet choose from the options listed below in blue font and add the suffix to the base model #

GENERAL

Series: Magiq
 Subseries: Magiq 2x2 Cell
 Brand: Prolicht
 Division: Architectural
 Mounting Type: Recessed
 Mounting Location: Ceiling
 Subcategory: Downlight

PHYSICAL

Shape: Square
 Length (mm): 90
 Length (in): 3 ⁹/₁₆
 Width (mm): 80
 Width (in): 3 ¹/₈
 Height (mm): 64
 Height (in): 2 ¹/₂
 Ceiling Thickness (mm): 10 / 12.5 / 15 / 25 / 30
 Ceiling Thickness (in): 3/8 or 1/2 or 9/16 or 1 or 1 3/16
 Min. Recessing Depth (mm): 100
 Min. Recessing Depth (in): 3 ¹⁵/₁₆
 Light Distribution: Downlight
 Weight (kg): 0.323
 Weight (lbs): 0.71
 Fixture Finish: SSR / BKV / CWI / CRY / HAB / UFT / ITA / RUA / FTG / MYG / LOD / PUS / FRO / FUP / KIA / POP / BLS / SPG / MEY / GOH / GUM / CHC / COM / ABZ / JAG / OBR / MOS / ROR
 Holder Finish: WHI / BLK
 Fixture Material: Aluminum Die Cast
 Cut-out Measurements: 73mm / 2 7/8" x 83mm / 3 1/4"

ELECTRICAL

Lamp Type: LED (Zhaga Standard)
 Input Wattage (W): 14.3
 Total Output Wattage (W): 13
 Dimming: Tri-Mode (Non-Dimming and Phase Dimming (120Vac only) and 0-10V Dimming)
 Driver Included: No
 Driver Location: Recessed Housing
 Driver Type: Constant Current - Universal
 Driver Class: Class 2
 Housing: See components
 Input Voltage (V): 120 - 277
 Constant Current (MA): 1050

LED

Number of LEDs: 4
 Color Temperature (°K): 2700 / 3000 / 3500 / 4000
 Max. Delivered Lumen (lm): 781 / 852 / 869 / 887
 Nominal Lumen (lm): 880 / 930 / 941 / 960
 CRI: >90 CRI
 Lamp Life (hrs): 50000

OPTICAL

Reflector: 8 / 18 / 34

RATINGS AND CERTIFICATIONS

Certified By: CSA Certified to UL and CSA Standards
 IP rating: IP20



MAGIQ 2X2 CELL RECESSED

A35633-

PROJECT	_____
TYPE	_____
SPECIFIER	_____
QUANTITY	_____
DATE	_____



PROJECT	_____
TYPE	_____
SPECIFIER	_____
QUANTITY	_____
DATE	_____

MAGIQ 2X2 CELL KORONA RECESSED

A35637-

base number	Color Temperature	Finishes (Diamond)	Finishes (Triangle)	Reflector Options	Finish Options
-------------	-------------------	--------------------	---------------------	-------------------	----------------

- To build a product code in our configurator select the specify button on the base model # product page
- To build a manual product code on this datasheet choose from the options listed below in blue font and add the suffix to the base model #

GENERAL

Series: Magiq
Subseries: Magiq 2x2 Cell Korona
Brand: Prolicht
Division: Architectural
Mounting Type: Recessed
Mounting Location: Ceiling
Subcategory: Downlight

PHYSICAL

Shape: Square
Length (mm): 80
Length (in): 3 1/8
Width (mm): 90
Width (in): 3 9/16
Height (mm): 64
Height (in): 2 1/2
Ceiling Thickness (mm): 10 / 12.5 / 15 / 25 / 30
Ceiling Thickness (in): 3/8 or 1/2 or 9/16 or 1 or 1 3/16
Min. Recessing Depth (mm): 100
Min. Recessing Depth (in): 3 15/16
Light Distribution: Downlight
Weight (kg): 0.265
Weight (lbs): 0.58
Fixture Finish: SSR / BKV / CWI / CRY / HAB / UFT / ITA / RUA / FTG / MYG / LOD / PUS / FRO / FUP / KIA / POP / BLS / SPG / MEY / GOH / GUM / CHC / COM / ABZ / JAG / OBR / MOS / ROR
Holder Finish: WHI / BLK
Fixture Material: Aluminum Die Cast
Cut-out Measurements: 73mm / 2 7/8" x 38mm / 1 1/2"

ELECTRICAL

Lamp Type: LED (Zhaga Standard)
Input Wattage (W): 17.8
Total Output Wattage (W): 13
Dimming: Tri-Mode (Non-Dimming and Phase Dimming (120Vac only) and 0-10V Dimming)
Driver Included: No
Driver Location: Recessed Housing
Driver Type: Constant Current - Universal
Driver Class: Class 2
Housing: See components
Input Voltage (V): 120 - 277
Constant Current (MA): 1050

LED

Number of LEDs: 4
Color Temperature (°K): 2700 / 3000 / 3500 / 4000
Max. Delivered Lumen (lm): Max 880
Nominal Lumen (lm): 880 / 960 / 980 / 1000
CRI: >90 CRI
Lamp Life (hrs): 50000

OPTICAL

Reflector: 8 / 18 / 34

RATINGS AND CERTIFICATIONS

Certified By: CSA Certified to UL and CSA Standards
IP rating: IP20



MAGIQ 2X2 CELL KORONA RECESSED

A35637-

PROJECT	_____
TYPE	_____
SPECIFIER	_____
QUANTITY	_____
DATE	_____



PROJECT _____
 TYPE _____
 SPECIFIER _____
 QUANTITY _____
 DATE _____

MAGIQ COLOR FINISH CHART

Fixture Finish

Sparkling Silver - 01 (SSR)



Black Velvet - 02 (BKV)



Crystal White - 03 (CWI)



Creamy - 04 (CRY)

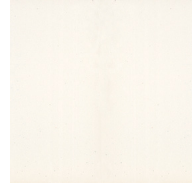

Hampton Bay - 05 (HAB)



Urban Forest - 07 (UFT)



In the Army - 08 (ITA)

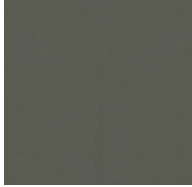

Rusty Angel - 09 (RUA)



Fade to Gray - 12 (FTG)



Mysterious Gray - 13 (MYG)

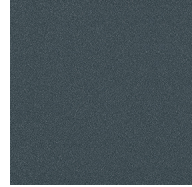

Lost Dream - 15 (LOD)



Purple Sky - 16 (PUS)



Fresh Oh - 17 (FRO)

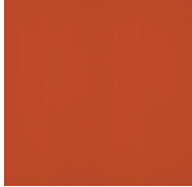

Funky P. - 18 (FUP)



Kissing Aphrodite - 19 (KIA)



Poseidon's Paradise - 20 (POP)

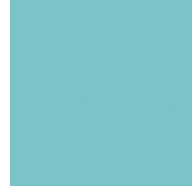

Blue Sky - 21 (BLS)



Spring Green - 22 (SPG)

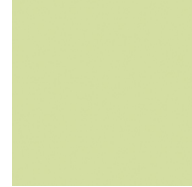

Mellow Yellow - 23 (MEY)



Golden Heart - 24 (GOH)



Gun Metal - 25 (GUM)



Champagne Cream - 26 (CHC)



Copper Mine - 27 (COM)



Ancient Bronze - 28 (ABZ)



Jazz Gold - 29 (JAG)



Olive Breeze - 30 (OBR)



Moonlight Silver - 31 (MOS)



Rosewood Red - 32 (ROR)



Holder Finish

White - WHI (WHI)

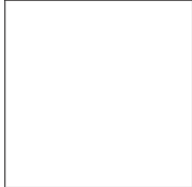

Black - BLK (BLK)



Digital: Not all screens are calibrated the same, and therefore, colors will appear differently between screens.
Physical: While the colors are as close as possible to the digital representation, there will be slight variations in color, character and tone within a product series and between product families.
 Available for International specifications by adding 'INT' at the end of the existing Model #. For assistance on 'custom' specifications, contact zteam@zaneen.com.
 In a constant supply of the product, the colors are not to change appearance and black color in particular which is more of a high quality finish and color are being identical.
Gun Metal, Mellow Yellow, Golden Heart, Rusty Angel, Kissing Aphrodite, Poseidon's Paradise, Blue Sky, Spring Green, Mellow Yellow, Golden Heart + Jazz Gold: These finishes have slight fading from specific powder coating production. Each luminaire will slightly vary.

PROJECT	
TYPE	
SPECIFIER	
QUANTITY	
DATE	

LEGEND

floor-mounted	pivotable	special LED (upon request) RGB, RGBW, tunable, gold+, meat+, art+, fashion+
wall and ceiling: recessed and surface mounted	rotating	warm dim / natural dimming LED
ceiling-mounted and wall-mounted	illuminate tilted	rechargeable battery powered
wall-mounted	color of suspension cable	fixture with natural vivid LED (upon request)
omni-directional light distribution	length of suspension cable	color rendering index
direct light distribution	reflector degree selection	color temperature
direct/indirect light distribution	super spot	lumen (luminous flux)
indirect light distribution	lens	efficacy (lumens per watt)
asymmetric light distribution	lens pack	Unified Glare Rating (UGR) range from 5-40
aura light distribution	shine ring	marine grade (AISI 316 stainless steel)
round wall or ceiling cut-out	integrated shine ring with diffuser	walk on
square wall or ceiling cut-out	free individual colors 01-29	drive on
the supplied jig specifies the cutout dimensions	individual colors: 00 (free of charge), 01-25 (extra charge)	Dark Sky Compliance
minimum distance (meters) lamp - object	luminaire part to be colored (F1)	Americans with Disabilities Act (less than 4" off the wall located between 27"-84" from floor)
recessed depth	luminaire part to be colored (F2)	lamp protected against explosion
ceiling thickness in mm	luminaire part to be colored (F3)	blown glass using traditional methods by master glass blower
ceiling thickness selection	luminaire part to be colored (F4)	acoustic material
dimmable DP (phase), DV (0-10V), DD (dali), DS (step-dim)	luminaire part to be colored (F5)	protection class I, protection insulation
included or excluded LED driver/transformer/control gear	color of 3-circuit adaptor	protection class II, protection insulation
separately switchable	indirect diffuser	ETL Certified to UL and CSA Standards
sensor	direct diffuser	UL Certified to UL and CSA Standards
remote control	ball-proof (upon request)	CSA Certified to UL and CSA Standards
available upon request	accessory	Certified for North American Standards

IP RATING

IP20	protected against ingress of solid bodies greater than 12.5mm (finger)
IP33	protected against ingress of solid bodies greater than 2.5mm protected against sprays of water up to 60 degrees from the vertical (rain)
IP40	protected against ingress of solid bodies greater than 1mm (wire) no protection against the ingress of moisture
IP43	protected against ingress of solid bodies greater than 1mm (wire) protected against sprays of water up to 60 degrees from the vertical (rain)
IP44	protected against ingress of solid bodies greater than 1mm (wire) protected against water splashed from all directions
IP54	protected against limited ingress of dust (wet rooms/covered outdoor areas) protected against water splashed from all directions
IP65	protected against ingress of dust protected against jets of water
IP66	protected against ingress of dust protected against powerful jets of water or heavy seas
IP67	protected against ingress of dust protected against immersion of water between 15cm - 1m for 30 minutes
IP68	protected against ingress of dust protected against immersion of water under pressure for long periods

IK RATING

IK01	protected against 0.14 joules impact (equivalent to 0.25kg mass dropped from 56mm above the surface)
IK02	protected against 0.2 joules impact (equivalent to 0.25kg mass dropped from 80mm above the surface)
IK03	protected against 0.35 joules impact (equivalent to 0.25kg mass dropped from 140mm above the surface)
IK04	protected against 0.5 joules impact (equivalent to 0.25kg mass dropped from 200mm above the surface)
IK05	protected against 0.7 joules impact (equivalent to 0.25kg mass dropped from 280mm above the surface)
IK06	protected against 1 joules impact (equivalent to 0.25kg mass dropped from 400mm above the surface)
IK07	protected against 2 joules impact (equivalent to 0.5kg mass dropped from 400mm above the surface)
IK08	protected against 5 joules impact (equivalent to 1.7kg mass dropped from 300mm above the surface)
IK09	protected against 10 joules impact (equivalent to 5.0kg mass dropped from 200mm above the surface)
IK10	protected against 20 joules impact (equivalent to 5.0kg mass dropped from 400mm above the surface)